

CD4511BC BCD-to-7 Segment Latch/Decoder/Driver

General Description

The CD4511BC BCD-to-seven segment latch/decoder/driver is constructed with complementary MOS (CMOS) enhancement mode devices and NPN bipolar output drivers in a single monolithic structure. The circuit provides the functions of a 4-bit storage latch, an 8421 BCD-to-seven segment decoder, and an output drive capability. Lamp test (LT), blanking (BI), and latch enable (LE) inputs are used to test the display, to turn-off or pulse modulate the brightness of the display, and to store a BCD code, respectively. It can be used with seven-segment light emitting diodes (LED), incandescent, fluorescent, gas discharge, or liquid crystal readouts either directly or indirectly.

Applications include instrument (e.g., counter, DVM, etc.) display driver, computer/calculator display driver, cockpit display driver, and various clock, watch, and timer uses.

Features

- Low logic circuit power dissipation
- High current sourcing outputs (up to 25 mA)
- Latch storage of code
- Blanking input
- Lamp test provision
- Readout blanking on all illegal input combinations
- Lamp intensity modulation capability
- Time share (multiplexing) facility
- Equivalent to Motorola MC14511

Ordering Code:

Order Number	Package Number	Package Description
CD4511BCWM	M16B	16-Lead Small Outline Integrated Circuit (SOIC), JEDEC MS-013, 0.300" Wide
CD4511BCN	N16E	16-Lead Plastic Dual-In-Line Package (PDIP), JEDEC MS-001, 0.300" Wide

Devices also available in Tape and Reel. Specify by appending suffix letter "X" to the ordering code.

Connection Diagrams

Pin Assignments for SOIC and DIP

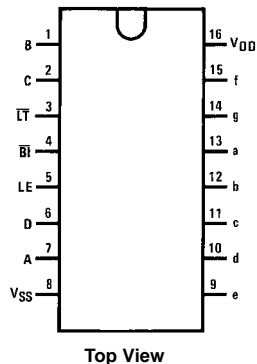

Segment Identification

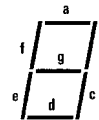

Truth Table

Inputs							Outputs							
LE	$\overline{\text{BI}}$	$\overline{\text{LT}}$	D	C	B	A	a	b	c	d	e	f	g	Display
X	X	0	X	X	X	X	1	1	1	1	1	1	1	B
X	0	1	X	X	X	X	0	0	0	0	0	0	0	
0	1	1	0	0	0	0	1	1	1	1	1	1	0	0
0	1	1	0	0	0	1	0	1	1	0	0	0	0	1
0	1	1	0	0	1	0	1	1	0	1	1	0	1	2
0	1	1	0	0	1	1	1	1	1	1	0	0	1	3
0	1	1	0	1	0	0	0	1	1	0	0	1	1	4
0	1	1	0	1	0	1	1	0	1	1	0	1	1	5
0	1	1	0	1	1	0	0	0	1	1	1	1	1	6
0	1	1	0	1	1	1	1	1	1	0	0	0	0	7
0	1	1	1	0	0	0	0	1	1	1	1	1	1	8
0	1	1	1	0	0	1	1	1	1	0	0	1	1	9
0	1	1	1	0	1	0	0	0	0	0	0	0	0	
0	1	1	1	0	1	1	0	0	0	0	0	0	0	
0	1	1	1	1	0	0	0	0	0	0	0	0	0	
0	1	1	1	1	1	0	1	0	0	0	0	0	0	
0	1	1	1	1	1	1	0	0	0	0	0	0	0	
0	1	1	1	1	1	1	0	0	0	0	0	0	0	
1	1	1	X	X	X	X				*				*

X = Don't Care

*Depends upon the BCD code applied during the 0 to 1 transition of LE.

Display



Absolute Maximum Ratings(Note 1)

DC Supply Voltage (V_{DD})	-0.5V to +18V
Input Voltage (V_{IN})	-0.5V to V_{DD} +0.5V
Storage Temperature Range (T_S)	-65°C to +150°C
Power Dissipation (P_D)	
Dual-In-Line	700 mW
Small Outline	500 mW
Lead Temperature (T_L)	
(Soldering, 10 seconds)	260°C

Recommended Operating Conditions

DC Supply Voltage (V_{DD})	3V to 15V
Input Voltage (V_{IN})	0V to V_{DD}
Operating Temperature Range (T_A)	-40°C to +85°C

Note 1: Devices should not be connected with power on.

DC Electrical Characteristics

Symbol	Parameter	Conditions	-40°C		+25°C			+85°C		Units
			Min	Max	Min	Typ	Max	Min	Max	
I_{DD}	Quiescent Supply Current	$V_{DD} = 5V$		20			20		150	μA
		$V_{DD} = 10V$		40		40		300	μA	
		$V_{DD} = 15V$		80		80		600	μA	
V_{OL}	Output Voltage Logical "0" Level	$V_{DD} = 5V$		0.01		0	0.01		0.05	V
		$V_{DD} = 10V$		0.01		0	0.01		0.05	V
		$V_{DD} = 15V$		0.01		0	0.01		0.05	V
V_{OH}	Output Voltage Logical "1" Level	$V_{DD} = 5V$	4.1		4.1	4.57		4.1		V
		$V_{DD} = 10V$	9.1		9.1	9.58		9.1		V
		$V_{DD} = 15V$	14.1		14.1	14.59		14.1		V
V_{IL}	LOW Level Input Voltage	$V_{DD} = 5V, V_{OUT} = 3.8V$ or 0.5V		1.5		2	1.5		1.5	V
		$V_{DD} = 10V, V_{OUT} = 8.8V$ or 1.0V		3.0		4	3.0		3.0	V
		$V_{DD} = 15V, V_{OUT} = 13.8V$ or 1.5V		4.0		6	4.0		4.0	V
V_{IH}	HIGH Level Input Voltage	$V_{DD} = 5V, V_{OUT} = 0.5V$ or 3.8V	3.5		3.5	3		3.5		V
		$V_{DD} = 10V, V_{OUT} = 1.0V$ or 8.8V	7.0		7.0	6		7.0		V
		$V_{DD} = 15V, V_{OUT} = 1.5V$ or 13.8V	11.0		11.0	9		11.0		V
V_{OH}	Output (Source) Drive Voltage	$V_{DD} = 5V, I_{OH} = 0$ mA	4.1		4.1	4.57		4.1		V
		$V_{DD} = 5V, I_{OH} = 5$ mA				4.24				V
		$V_{DD} = 5V, I_{OH} = 10$ mA	3.6		3.6	4.12		3.3		V
		$V_{DD} = 5V, I_{OH} = 15$ mA				3.94				V
		$V_{DD} = 5V, I_{OH} = 20$ mA	2.8		2.8	3.75		2.5		V
		$V_{DD} = 5V, I_{OH} = 25$ mA				3.54				V
		$V_{DD} = 10V, I_{OH} = 0$ mA	9.1		9.1	9.58		9.1		V
		$V_{DD} = 10V, I_{OH} = 5$ mA				9.26				V
		$V_{DD} = 10V, I_{OH} = 10$ mA	8.75		8.75	9.17		8.45		V
		$V_{DD} = 10V, I_{OH} = 15$ mA				9.04				V
		$V_{DD} = 10V, I_{OH} = 20$ mA	8.1		8.1	8.9		7.8		V
		$V_{DD} = 10V, I_{OH} = 25$ mA				8.75				V
		$V_{DD} = 15V, I_{OH} = 0$ mA	14.1		14.1	14.59		14.1		V
		$V_{DD} = 15V, I_{OH} = 5$ mA				14.27				V
		$V_{DD} = 15V, I_{OH} = 10$ mA	13.75		13.75	14.18		13.45		V
		$V_{DD} = 15V, I_{OH} = 15$ mA				14.07				V
		$V_{DD} = 15V, I_{OH} = 20$ mA	13.1		13.1	13.95		12.8		V
		$V_{DD} = 15V, I_{OH} = 25$ mA				13.8				V
I_{OL}	LOW Level Output Current	$V_{DD} = 5V, V_{OL} = 0.4V$	0.52		0.44	0.88		0.36		mA
		$V_{DD} = 10V, V_{OL} = 0.5V$	1.3		1.1	2.25		0.9		mA
		$V_{DD} = 15V, V_{OL} = 1.5V$	3.6		3.0	8.8		2.4		mA
I_{IN}	Input Current	$V_{DD} = 15V, V_{IN} = 0V$		-0.30		-10^{-5}	-0.30		-1.0	μA
		$V_{DD} = 15V, V_{IN} = 15V$		0.30		10^{-5}	0.30		1.0	μA

AC Electrical Characteristics (Note 2) $T_A = 25^\circ\text{C}$ and $C_L = 50\text{ pF}$, typical temperature coefficient for all values of $V_{DD} = 0.3\%/^\circ\text{C}$

Symbol	Parameter	Conditions	Min	Typ	Max	Units
C_{IN}	Input Capacitance	$V_{IN} = 0$		5.0	7.5	pF
t_r	Output Rise Time (Figure 1a)	$V_{DD} = 5V$		40	80	ns
		$V_{DD} = 10V$		30	60	ns
		$V_{DD} = 15V$		25	50	ns
t_f	Output Fall Time (Figure 1a)	$V_{DD} = 5V$		125	250	ns
		$V_{DD} = 10V$		75	150	ns
		$V_{DD} = 15V$		65	130	ns
t_{PLH}	Turn-Off Delay Time (Data) (Figure 1a)	$V_{DD} = 5V$		640	1280	ns
		$V_{DD} = 10V$		250	500	ns
		$V_{DD} = 15V$		175	350	ns
t_{PHL}	Turn-On Delay Time (Data) (Figure 1a)	$V_{DD} = 5V$		720	1440	ns
		$V_{DD} = 10V$		290	580	ns
		$V_{DD} = 15V$		195	400	ns
t_{PLH}	Turn-Off Delay Time (Blank) (Figure 1a)	$V_{DD} = 5V$		320	640	ns
		$V_{DD} = 10V$		130	260	ns
		$V_{DD} = 15V$		100	200	ns
t_{PHL}	Turn-On Delay Time (Blank) (Figure 1a)	$V_{DD} = 5V$		485	970	ns
		$V_{DD} = 10V$		200	400	ns
		$V_{DD} = 15V$		160	320	ns
t_{PLH}	Turn-Off Delay Time (Lamp Test) (Figure 1a)	$V_{DD} = 5V$		313	625	ns
		$V_{DD} = 10V$		125	250	ns
		$V_{DD} = 15V$		90	180	ns
t_{PHL}	Turn-On Delay Time (Lamp Test) (Figure 1 a)	$V_{DD} = 5V$		313	625	ns
		$V_{DD} = 10V$		125	250	ns
		$V_{DD} = 15V$		90	180	ns
t_{SETUP}	Setup Time (Figure 1b)	$V_{DD} = 5V$	180	90		ns
		$V_{DD} = 10V$	76	38		ns
		$V_{DD} = 15V$	40	20		ns
t_{HOLD}	Hold Time (Figure 1b)	$V_{DD} = 5V$	0	-90		ns
		$V_{DD} = 10V$	0	-38		ns
		$V_{DD} = 15V$	0	-20		ns
PW_{LE}	Minimum Latch Enable Pulse Width (Figure 1 c)	$V_{DD} = 5V$	520	260		ns
		$V_{DD} = 10V$	220	110		ns
		$V_{DD} = 15V$	130	65		ns

Note 2: AC Parameters are guaranteed by DC correlated testing.

Switching Time Waveforms

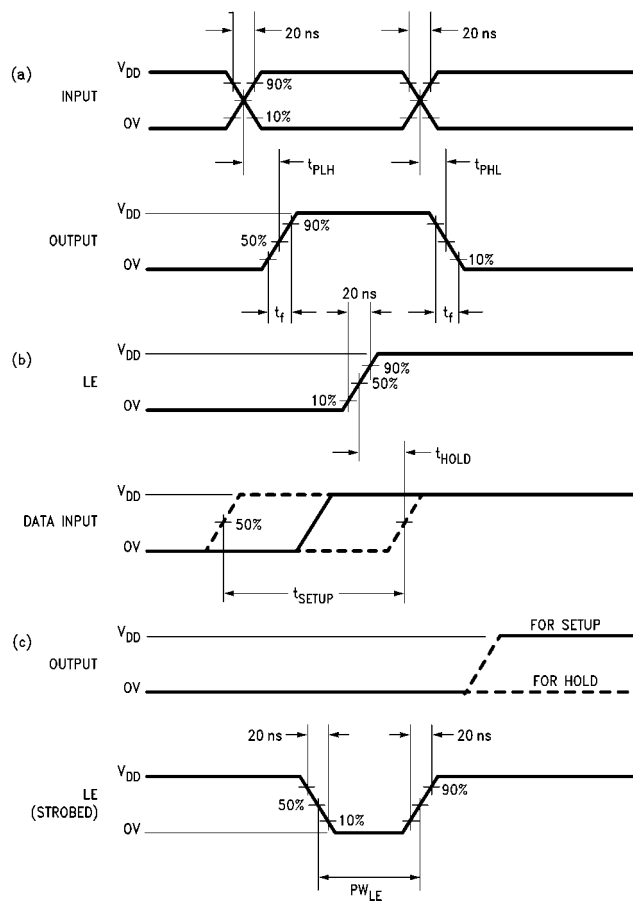
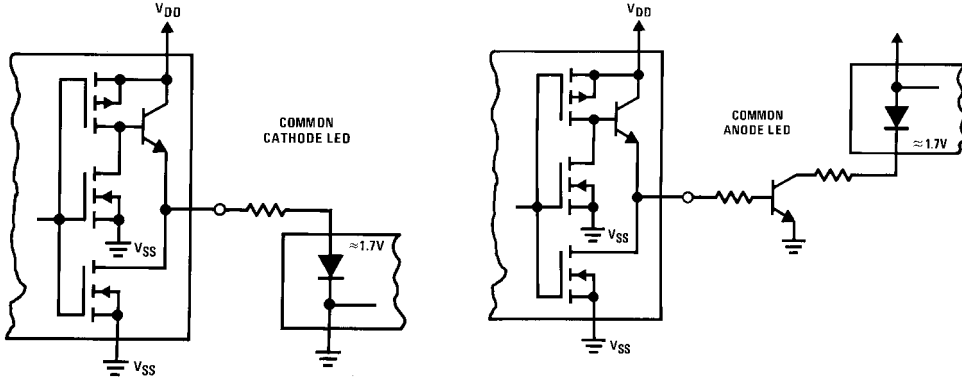

FIGURE 1.

Typical Applications

Light Emitting Diode (LED) Readout



Gas Discharge Readout

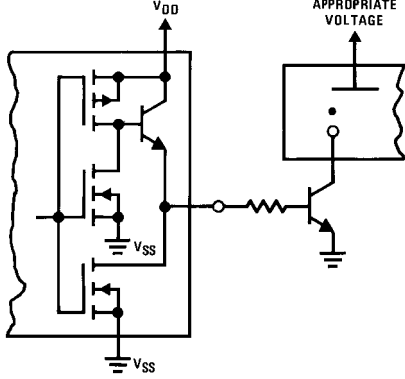

Liquid Crystal (LC) Readout

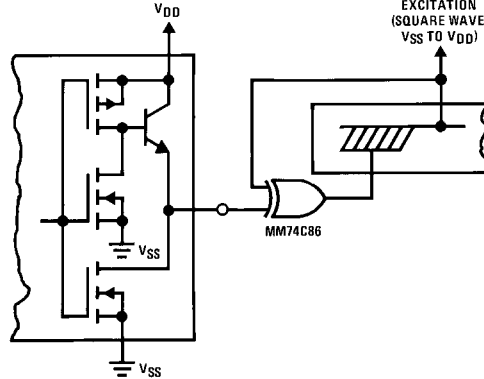

Direct DC drive of LC's not recommended for life of LC readouts.

Incandescent Readout

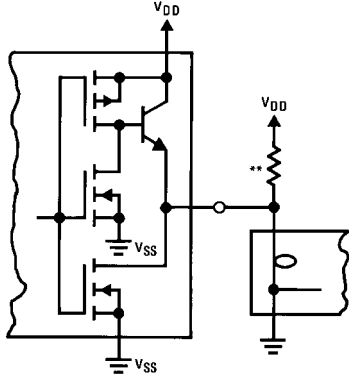

**A filament pre-warm resistor is recommended to reduce filament thermal shock and increase the effective cold resistance of the filament.

Fluorescent Readout

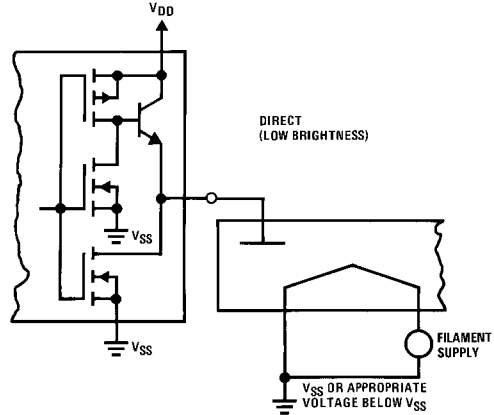

Physical Dimensions inches (millimeters) unless otherwise noted

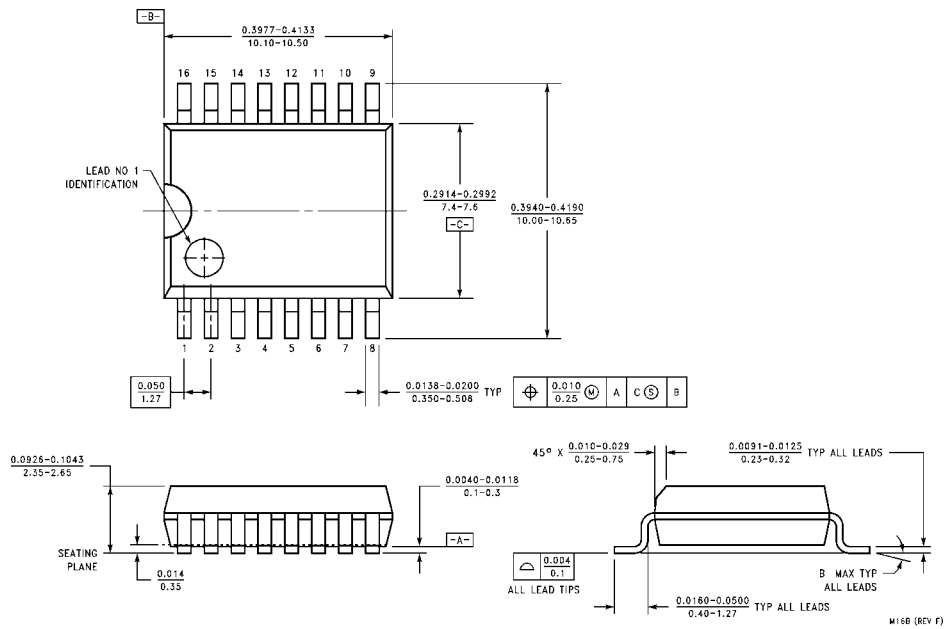

**16-Lead Small Outline Integrated Circuit (SOIC), JEDEC MS-013, 0.300" Wide
Package Number M16B**

Physical Dimensions inches (millimeters) unless otherwise noted (Continued)

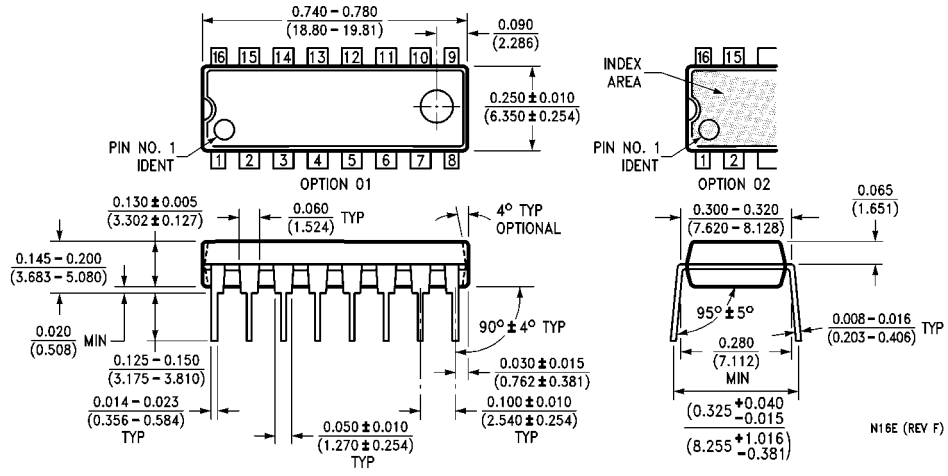

16-Lead Plastic Dual-In-Line Package (PDIP), JEDEC MS-001, 0.300" Wide Package Number N16E

LIFE SUPPORT POLICY

FAIRCHILD'S PRODUCTS ARE NOT AUTHORIZED FOR USE AS CRITICAL COMPONENTS IN LIFE SUPPORT DEVICES OR SYSTEMS WITHOUT THE EXPRESS WRITTEN APPROVAL OF THE PRESIDENT OF FAIRCHILD SEMICONDUCTOR CORPORATION. As used herein:

1. Life support devices or systems are devices or systems which, (a) are intended for surgical implant into the body, or (b) support or sustain life, and (c) whose failure to perform when properly used in accordance with instructions for use provided in the labeling, can be reasonably expected to result in a significant injury to the user.
2. A critical component in any component of a life support device or system whose failure to perform can be reasonably expected to cause the failure of the life support device or system, or to affect its safety or effectiveness.

www.fairchildsemi.com