

FEATURES

- * 0.6 INCH (15 mm) DIGIT HEIGHT.
- * CONTINUOUS UNIFORM SEGMENTS.
- * LOW POWER REQUIREMENT.
- * LONG DISTANCE VIEWING.
- * COLOR FILTER PROVIDES HIGH CONTRAST.
- * HIGH RELIABILITY AND LONG LIFE.
- * WIDE VIEWING ANGLE.
- * FULL FEATURE SELECTABLE.
- * FREQUENCY DISPLAY.
- * DESIGNED FOR CLOCK INDICATION, TIMER FREQUENCY COUNTER, INSTRUMENT...,ETC.

DESCRIPTION

The LTC-637D1P is a 0.6 inch (15 mm) digit height display. This device utilizes bright red LED chips, which are made from GaP on a transparent GaP substrate. A red film is added on it.

DEVICE

PART NO.	DESCRIPTION
Bright Red	
LTC-637D1P	Common Cathode

PACKAGE DIMENSIONS

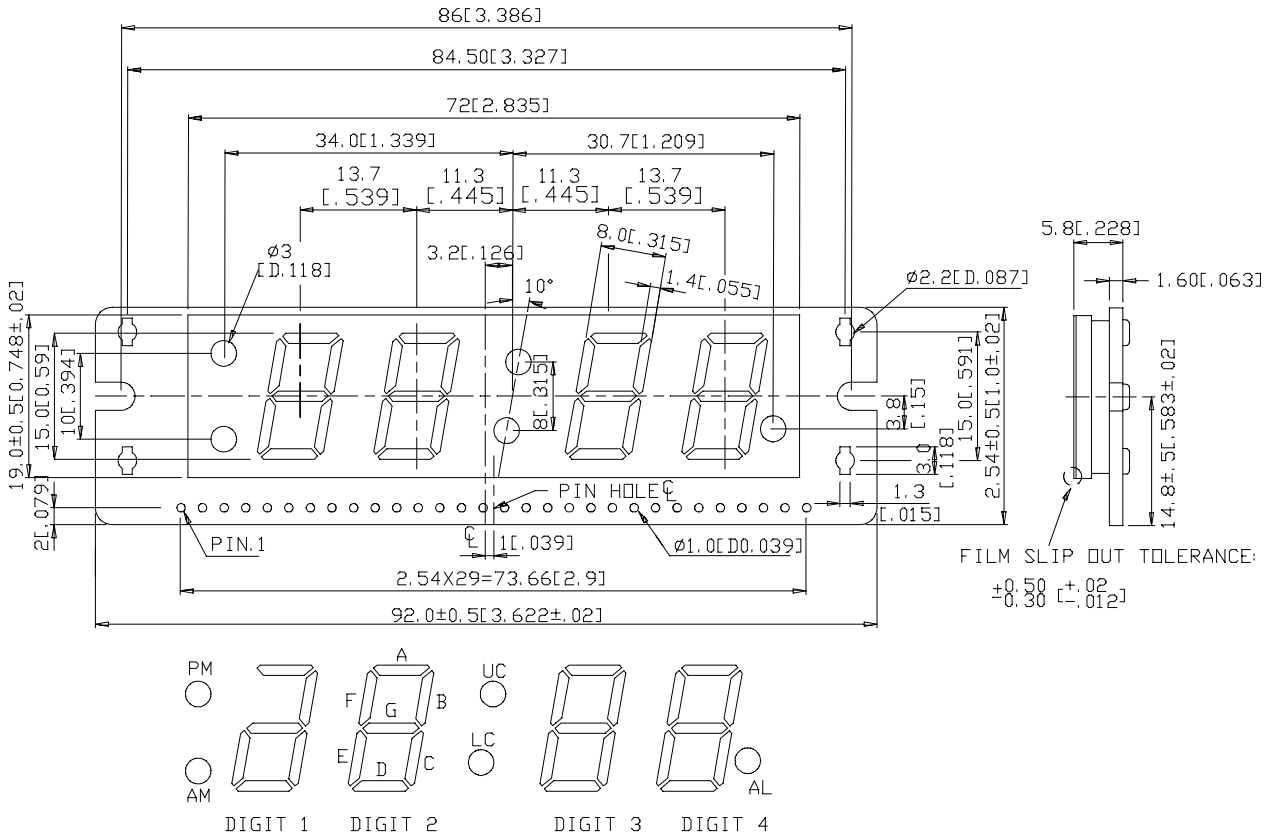

NOTES: All dimensions are in millimeters. Tolerance is ± 0.25-mm (0.01") unless otherwise noted.

INTERNAL CIRCUIT DIAGRAM

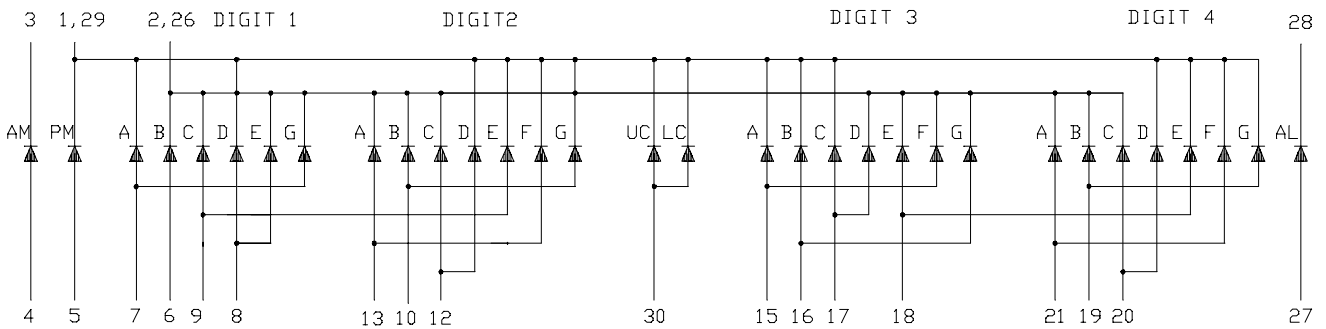

PIN CONNECTION

NO.	CONNECTION	NO.	CONNECTION
1	Common Cathode (Digit 1,A,D ; Digit 2,D,E,F,G ; Digit 3,A,B,C ; Digit 4,D,E,F,G ; PM,UC,LC)	16	Digit 3 Anode B, Digit 3 Anode G
2	Common Cathode (Digit 1,B,C,E,G ; Digit 2,A,B,C ; Digit 3,D,E,F,G ; Digit 4,A,B,C)	17	Digit 3 Anode C, Digit 3 Anode D
3	Cathode AM	18	Digit 3 Anode E, Digit 4 Anode E
4	Anode AM	19	Digit 4 Anode B, Digit 4 Anode G
5	Anode PM	20	Digit 4 Anode C, Digit 4 Anode D
6	Digit 1 Anode B	21	Digit 4 Anode A, Digit 4 Anode F
7	Digit 1 Anode A, Digit 1 Anode G	22	No Connection
8	Digit 1 Anode D, Digit 1 Anode E	23	No Connection
9	Digit 2 Anode E, Digit 1 Anode C	24	No Connection
10	Digit 2 Anode B, Digit 2 Anode G	25	No Connection
11	No Connection	26	Common Cathode (Digit 1,B,C,E,G ; Digit 2,A,B,C ; Digit 3,D,E,F,G ; Digit 4,A,B,C)
12	Digit 2 Anode C, Digit 2 Anode D	27	Anode AL
13	Digit 2 Anode A, Digit 2 Anode F	28	Cathode AL
14	No Connection	29	Common Cathode (Digit 1,A,D ; Digit 2,D,E,F,G ; Digit 3,A,B,C ; Digit 4,D,E,F,G ; PM,UC,LC)
15	Digit 3 Anode A, Digit 3 Anode F	30	Anode UC, Anode LC

ABSOLUTE MAXIMUM RATING AT T_A=25°C

PARAMETER	MAXIMUM RATING	UNIT
Power Dissipation Per Segment	40	mW
Peak Forward Current Per Segment (1/10 Duty Cycle, 0.1ms Pulse Width)	60	mA
Continuous Forward Current Per Segment	15	mA
Forward Voltage, Per Segment	0.2	mA/°C
Reverse Voltage Per Segment	5	V
Operating Temperature Range	-25°C to +65°C	
Storage Temperature Range	-25°C to +65°C	
Solder Temperature: 3.5mm Below PCB.back side for 3sec. at 260°C		

ELECTRICAL / OPTICAL CHARACTERISTICS AT T_A=25°C

PARAMETER	SYMBOL	MIN.	TYP.	MAX.	UNIT	TEST CONDITION
Average Luminous Intensity	I _v	125	350		μcd	I _F =10mA
Peak Emission Wavelength	λ _p		697		nm	I _F =20mA
Spectral Line Half-Width	Δλ		90		nm	I _F =20mA
Dominant Wavelength	λ _d		657		nm	I _F =20mA
Forward Voltage Per Segment	V _F		2.1	2.6	V	I _F =20mA
Reverse Current Per Segment	I _R			100	μA	V _R =5V
Luminous Intensity Matching Ratio	I _v -m			2:1		I _F =10mA

Note: Luminous intensity is measured with a light sensor and filter combination that approximates the CIE (Commision Internationale De L'Eclariage) eye-response curve.

TYPICAL ELECTRICAL / OPTICAL CHARACTERISTIC CURVES

(25°C Ambient Temperature Unless Otherwise Noted)

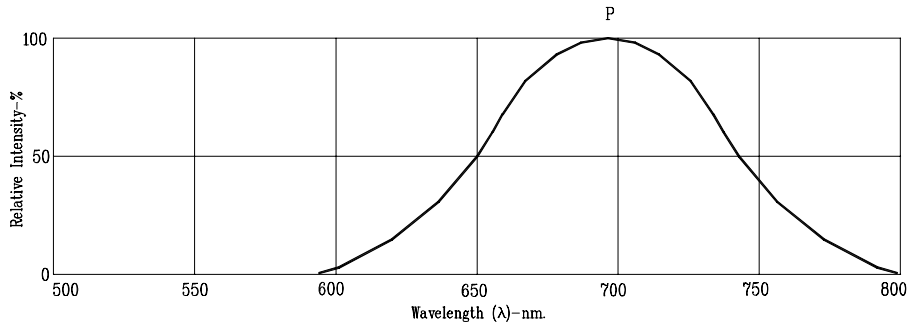

Fig1. RELATIVE INTENSITY VS. WAVELENGTH

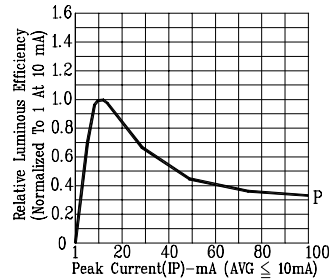

Fig2. RELATIVE LUMINOUS EFFICIENCY (LUMINOUS INTENSITY PER UNIT CURRENT) VS. PEAK CURRENT (REFRESH RATE 1KHz)

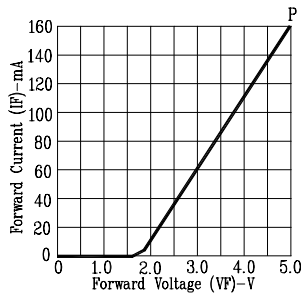

Fig3. FORWARD CURRENT VS. FORWARD VOLTAGE

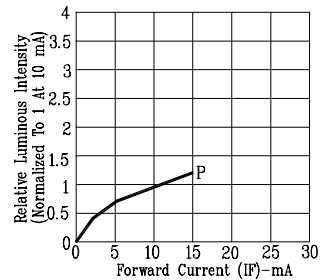

Fig4. RELATIVE LUMINOUS INTENSITY VS. FORWARD CURRENT

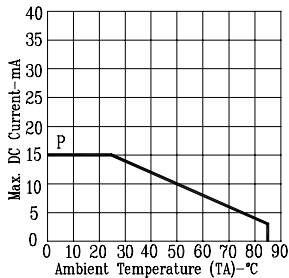

Fig5. MAX ALLOWABLE DC CURRENT VS. AMBIENT TEMPERATURE.

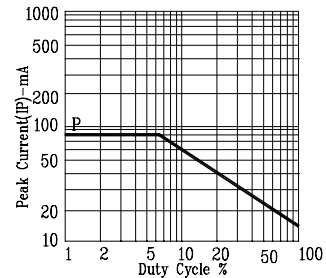

Fig6. MAX PEAK CURRENT VS. DUTY CYCLE % (REFRESH RATE 1KHz)

NOTE: P=BRIGHT RED